

Data Sheet



Article number: 20329314

Description: E+G Handwheel
GN 555-160-B14-A

Measures

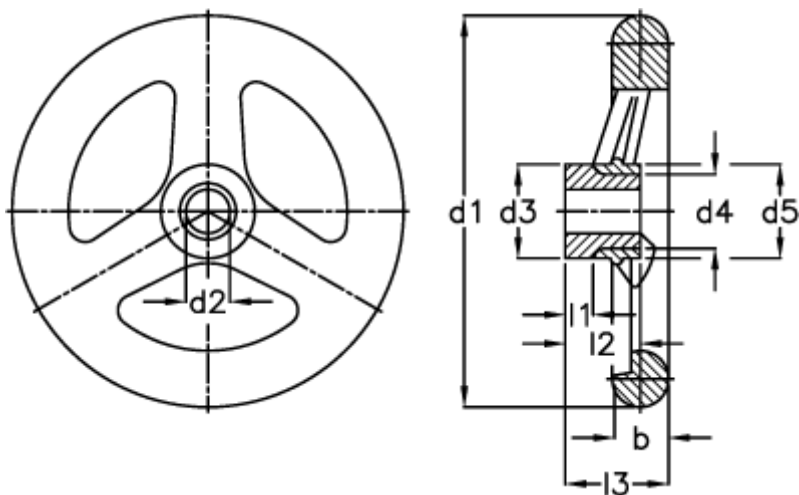

b	= 22	l2 -0.5	= 28
d1	= 160	l3	= 40
d2 H7	= 16	Number of spokes	= 3
d2 H7	= 14		
d3	= 32		
d4	= 24		
d5	= 37		
l1 -0.5	= 5		